



Safety



ARSENAL®

Technology Provider



Traffic Safety Systems

2018-2019 Product Catalogue



Safety Arsenal Technology Provider



Tel: +216 71 85 80 84

Mobile: +216 22 222 000

Mail: contact@safetyarsenal.com

www.safetyarsenal.com

Dialog For Success

Sustainability of our policy which is solution-focused production, selling and support is based on the dialog that is really important for us. As our dealers and customers together evelux family; being in the dialog paying regard to our benefits is main reason of a. aining the success.



Trust For Dialog

Our ongoing stabilizaon policy including a quality based on the t echnology, an economy based on the costs and on-me deliv ery, is commiÄed to each other as **evelux** family, trusully .



Marketing&Selling

Network

We supply local market demand from our stock via our local dealers. In foreign market, delivery provided by our foreign partners over ABD, Europe and Middle East Africa regions. Thus, we provide service to our all customers by on-me` and economical way.

Delivery From ready Stocks

Main criterion of our market closeness policy is on-me` delivery. To provide this criterion, we developed our selling systems (sales&markeng` and export) oriented local and foreign market. For local market, we`ve established our local dealers based on the sales&marke. ng system; for foreign market, we`ve organized our foreign partners based on the export system.



Quality for Trust



Our self-confidence in customer relaons and selling policy, is based on our quality policy. Our all departments are equipped with a high quality sense based on our knowledge and the tecnology; and are cerfied` with ISO 9001:2008 and K-Q / TSE-ISO-EN 9000.



TS EN 13422+A1

PVC Cones (90 cm)



12321 TK 12325 TK R2 12327 TK A R2 12329 TK 12331 TK R2

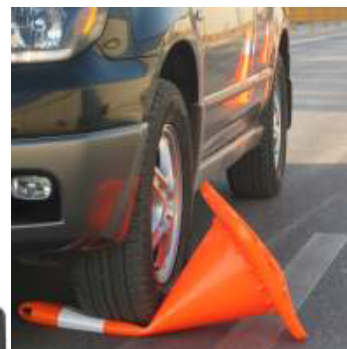

Flexibility 100%

Product Technical Specifications					
Part.N	12321 TK	12325 TK R2	12327 TK A R2	12329 TK	12331 TK R2
size(AxH)	385x900 mm	385x900 mm	485x900 mm	385x900 mm	385x900 mm
Weight(approx.)	3.6 kg	3.6 kg	6.9 kg	4.0 kg	4.0 kg
Material	PVC	PVC	PVC	PVC	PVC



190 A

TSE BELGE / EN 13422+A1

PVC Cones (75 cm)



12305 TK 12307 TK R1 12309 TK R2 12315 TK A R2

Product Technical Specifications				
Part.N	12305 TK	12307 TK R1	12309 TK R2	12315 TK A R2
size(AxH)	385x750 mm	385x750 mm	385x750 mm	485x750 mm
Weight(approx.)	3.2 kg	3.2 kg	3.2 kg	6.5 kg
Material	PVC	PVC	PVC	PVC

Product Technical Specifications

Part No.	12305 TK	12307 TK A
Dim.(AxH)	350x500 mm	350x520 mm
Weight(approx.)	1.15 kg	4.0 kg
Material	PPC	PPC-PVC(base)

Belows are panel cones alternavães.

TSE BELGE / EN 13422+A1

PVC Cones (70/50 cm)



12333 TK 12335 TK R1 12337 TK R2 12328 TK 12330 TK R1 12332 TK R2

Product Technical Specifications						
Part.N	12333 TK	12335 TK R1	12337 TK R2	12328 TK	12330 TK R1	12332 TK R2
size(AxH)	380x700 mm	380x700 mm	380x700 mm	320x520 mm	320x520 mm	320x520 mm
Weight(approx.)	2.3 kg	2.3 kg	2.3 kg	1.25 kg	1.25 kg	1.25 kg
Material	PVC	PVC	PVC	PVC	PVC	PVC



126 A



174 A

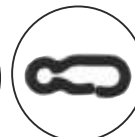

175 A

PVC Cones (50/32 cm)



12304 TK 12306 TK R1 12326 TK A R1 12317 TK 12318 TK R1 12314 TK 12316 TK R2 12303 TK R1

Product Technical Specifications								
code	12304 TK	12306 TK R1	12326 TK A R1	12317 TK	12318 TK R1	12314 TK	12316 TK R2	12303 TK R1
size(AxH)	285x500 mm	285x500 mm	385x500 mm	350x500 mm	350x500 mm	350x500 mm	350x500 mm	220x320 mm
Weight (approx)	1.3 kg	1.3 kg	2.65 kg	1.8 kg	1.8 kg	1.7 kg	1.7 kg	0.650 kg
Material	PVC	PVC	PVC	PVC	PVC	PVC	PVC	PVC

PVC Cones



12300 TK



12301 TK A



12350 TK



12351 TK A



12352 TK A

Product Technical Specificaons

code	12300 TK	12301 TK A	12350 TK	12351 TK A	12352 TK A
size(AxH)	350x500mm	350x520mm	370x600mm	370x613mm	370x613mm
Weight (approx)	1.15 kg	4.0 kg	1.5 kg	5.15 kg	5.15 kg
Material	PPC	PPC-PVC(base)	PPC	PPC-PVC(base)	PPC-PVC(base)

PP Cones



12302 TK



12320 TK A R2



12322 TK R2



12421 DB R A



12424 DB R A

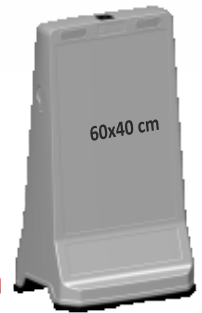

12426 DB A

Product Technical Specificaons

code	12302 TK	12320 TK A R2	12322 TK R2	12421 DB R A	12424 DB A	12426 DB R A
size	(AxH)350x500	(AxH)460x750	(AxH)400x750		(LxWxH)495x395x905	
Weight (approx)	0.85 kg	4.9 kg	2.2 kg		7.5 kg	
Material(Body-Base)	PPC	PPC-PVC(base)	PPC		PPC-PVC	

FOLDABL FLOOR SIGN



107 A



108 A F

Product Technical Specificaons

code	107 A	108 A F	12365 LD A
size(WxH)	245x620 mm	245x620 mm	Ø110x800 mm
Weight (approx)	1.35kg	1.35kg	11.9kg
Material(Body-Base)	ABS	ABS	PE-PPC

PAVEMENT SIGN POSTS



12365 LD A



color ALTERNATİFLERİ



SIGN CARRYING BOLLARDS

Product Technical Specificaons

code	12253 UB R	12254 UB R	12255 UB R
size(ØxH)	100x800 mm	200x900 mm	300x1000 mm
Weight (approx)	1.4 kg	2.0 kg	3.25 kg
Material	TPU-PU	TPU-PU	TPU-PU



Channelizer

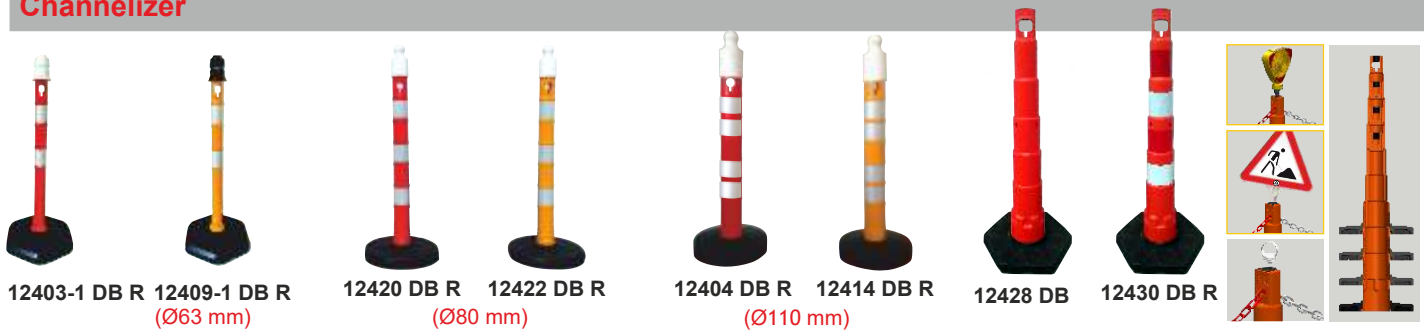

Product Technical Specifications

code	12403-1 DB R	12409-1 DB R	12420 DB R	12422 DB R	12404 DB R	12414 DB R	12428 DB	12430 DB R
size (ØxH)	63x1000mm	63x1000mm	80x1100 mm	80x1100 mm	110x1200 mm	110x1200 mm	120x14 cm	120x14 cm
Weight (approx)	4.0 kg	4.0 kg	6.5 kg	6.5 kg	12.0 kg	12.0 kg	8.7 kg	8.7 kg
Material	PPC-PVC	PPC-PVC	PPC-PVC	PPC-PVC	PPC	PPC	PPC-PVC	PPC-PVC

Posts-Barriers-Barricades



Product Technical Specifications

code	12405 DB R	12407 DB R
Size Barrier(WxH)	1800x1200mm	1800x1200mm
Dimensions(ØxH)	110x1200mm	110x1200mm
Weight (approx)	31.0 kg	27.0 kg
Material(body-panel)	PPC-PVC	PPC-PVC

Reflective ASTM D 4956-11a Type I

Foldable Traffic Sign Barricades

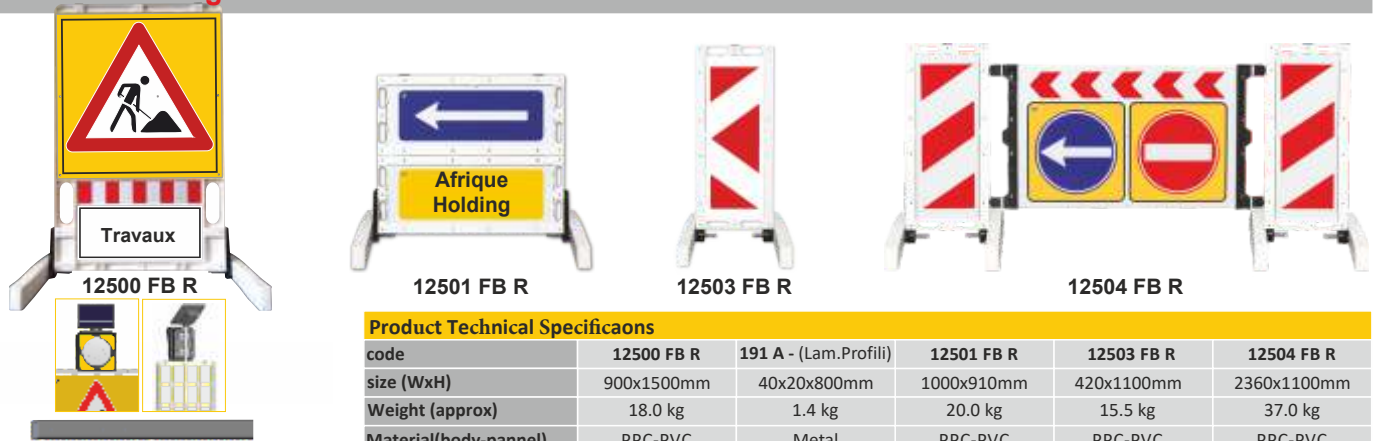

Product Technical Specifications

code	12500 FB R	191 A - (Lam.Profil)	12501 FB R	12503 FB R	12504 FB R
size (WxH)	900x1500mm	40x20x800mm	1000x910mm	420x1100mm	2360x1100mm
Weight (approx)	18.0 kg	1.4 kg	20.0 kg	15.5 kg	37.0 kg
Material(body-panel)	PPC-PVC	Metal	PPC-PVC	PPC-PVC	PPC-PVC

191 A

(4x2x80 cm-Lamp Profile)

Foldable Traffic Sign Barricades



Reflective TS EN 13422+A1

REFLECTIV ASTM D 4956-11a Type I

Product Technical Specifications

code	12417 DB R	12410 DB R	12415 DB R	12416 DB R
size Bariyer (LxWxH)	480x600x900mm	480x250x1200mm	480x200x1000mm	450x200x700mm
size Panel (WxH)	600x600mm	250x1000mm	200x800mm	200x500mm
Weight (approx)	12.0 kg	12.0 kg	11.0 kg	6.5 kg
Material(body-panel)	PPC-PVC	PPC-PVC	PPC-PVC	PPC-PVC

Removable sealing bollard

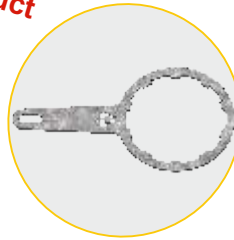
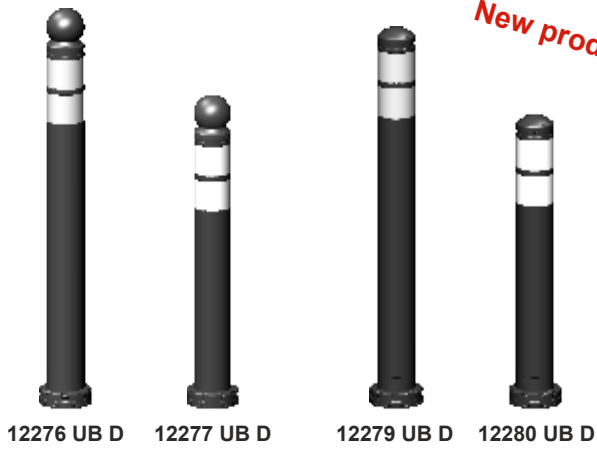

188 A key

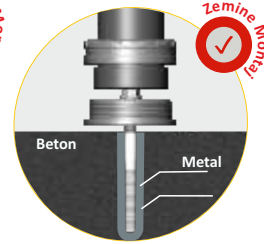
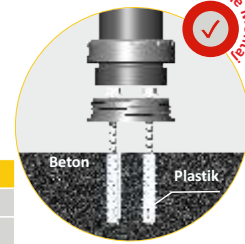
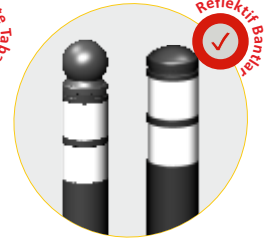
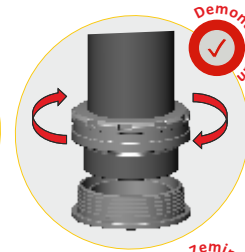

Product Technical Specifications					
code	12276 UB D	12277 UB D	12279 UB D	12280 UB D	188 A
Size	(HxØ)87x8.0cm	(HxØ)68x8.0cm	(HxØ)81.5x8.0cm	(HxØ)62.5x8.0cm	Ø11 cm
Diameter	Ø11cm	Ø11cm	Ø11cm	Ø11cm	-
Weight (approx)	1.72 kg	1.38 kg	1.62 kg	1.28 kg	0.17 kg
Material	TPU-PA	TPU-PA	TPU-PA	TPU-PA	Metal

Alternative Application Option

UV - résistant

Anti-Parking Bollard



Product Technical Specifications				
code	12289 UB ST	12293 UB ST	12287 UB ST	12285 UB PU
Size ±%5	(HxØ) 78x15 cm	(HxØ) 61 x15 cm	(HxØ) 78x15 cm	(HxØ) 78x15 cm
Base	(LxW)24.5x24.5 cm	(LxW)24.5x24.5 cm	Ø15x18 cm	Ø17x18 cm
Weight (±%5)	9.70 kg	8.2 kg	7.3 kg	3.3 kg
Material	Metal	Metal	Metal	PU



FLEXIBLE DELINEATOR

Product Technical Specifications						
code	12274 UB R	12272 UB R	12215 UB R	12214 UB R	12212 UB R	12211 UB R
size(ØxH)	40x8.0cm	70x8.0cm	80x300 mm	80x450 mm	80x750 mm	80x1000 mm
Weight (approx)	0.52 kg	0.74 kg	0.720 kg	0.980 kg	1.3 kg	1.6 kg
Material	TPE	TPE	TPU-PU	TPU-PU	TPU-PU	TPU-PU

TSE BELGE / EN 13422+A1

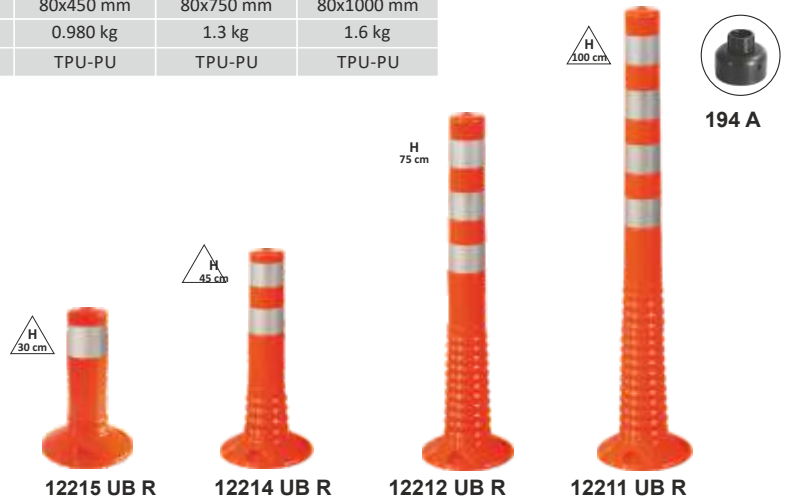

FLEXIBLE DELINEATOR

12242 UB R - 12286 UB R

Product Technical Specificaons				
code	12241 UB R 12288 UB R 12221UB R	12242 UB R 12286 UB R 12222UB R	12244 UB R 12284 UB R 12224UB R	12245 UB R 12282 UB R 12225 UB R
size(ØxH)	80x1000 mm	80x750 mm	80x450 mm	80x300 mm
Weight (approx)	1.6 kg	1.3 kg	0.980 kg	0.720 kg
Material	TPU-PU	TPU-PU	TPU-PU	TPU-PU

TSE BELGE / EN 13422+A1

12241 UB R - 12288 UB R - 12221 UB R
12222 UB R 12244 UB R - 12284 UB R 12224 UB R 12245 UB R - 12282 UB R 12225 UB R

GLUE DOWN FLEXIBLE DELINEATOR

model model
1 2

12258 UB R 12256 UB R
12232 UB R 12236 UB R
12232 UB R-Y 12236 UB R-Y
12232 UB R-W 12236 UB R-W

Product Technical Specificaons								
code	12258 UB R	12256 UB R	12232 UB R	12236 UB R	12232 UB R-Y	12236 UB R-Y	12232 UB R-W	12236 UB R-W
size(ØxH)	100x500 mm	100x800 mm	80x750 mm	80x450 mm	80x750 mm	80x450 mm	80x750 mm	80x450 mm
Weight (approx)	0.950 kg	1.4 kg	1.48 kg	1.1 kg	1.48kg	1.1 kg	1.48 kg	1.1 kg
Material	TPU-PU	TPU-PU	TPU-ABS	TPU-ABS	TPU-ABS	TPU-ABS	TPU-ABS	TPU-ABS

CHANNELIZERS WITH DELINEATOR

12270 UB R
12268 UB R
12218 UB R
12219 UB R

Product Technical Specificaons				
code	12270 UB R	12268 UB R	12218 UB R	12219 UB R
size(LxWxH)	1000x220x455mm	1000x220x755mm	1000x200x455mm	1000x200x755mm
Weight (approx)	3.85 kg	4.25 kg	4.15 kg	4.5 kg
Material	TPU-PPC	TPU-PPC	TPU-PPC	TPU-PPC

TSE BELGE / EN 13422+A1

CHANNELIZERS WITH FLAP

12266 UB R
12203 UB R
12204 UB R
12207 UB R
12206 UB R

Product Technical Specificaons					
code	12266 UB R	12203 UB R	12204 UB R	12207 UB R	12206 UB R
size(LxWxH)	1000x220x650mm	1200x150x280mm	1200x150x600mm	260x160x280mm	260x160x600mm
Weight (approx)	3.6 kg	2.5 kg	2.7 kg	0.750 kg	0.900 kg
Material	PPC-PPC	PE-PPC	PE-PPC	PE-PPC	PE-PPC

PEDESTRIAN CHANNELIZERS



Product Technical Specificaons			
code	12213 UB R	12223 UB R	12205 UB R
size(LxWxH)	200x800 mm	200x500 mm	270x500 mm
Weight (approx)	1.25 kg	0.90 kg	1.5 kg
Material	PPC	PPC	PE



Parking Curbs

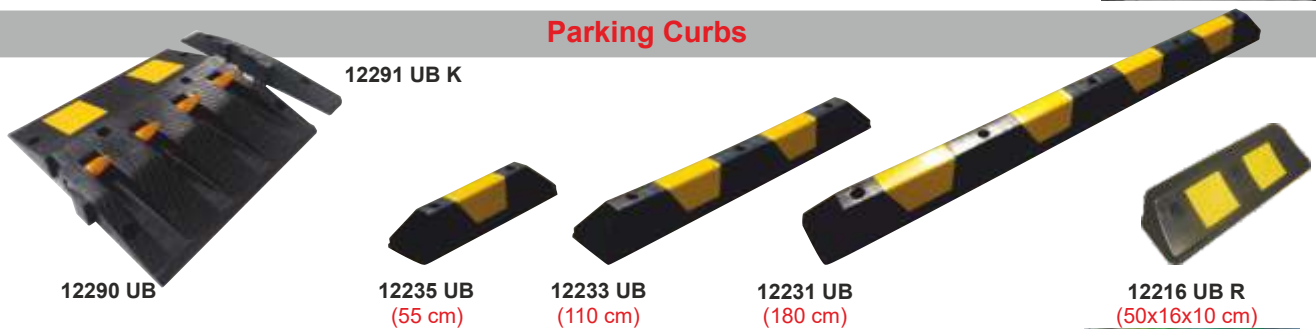

Product Technical Specificaons						
code	12290 UB	12291 UB K	12235 UB	12233 UB	12231 UB	12216 UB R
size(LxWxH)	500x500x60mm	500x90x60mm	550x150x100mm	1100x150x100mm	1800x150x100mm	500x160x100mm
Weight (approx)	7.3 kg	0.70 kg	1.9 kg	4.25 kg	6.8 kg	2.45 kg
Material	Metal-PPC	PPC	PPC	PPC	PPC	PVC



TRAFFIC SAFETY MIRRORS

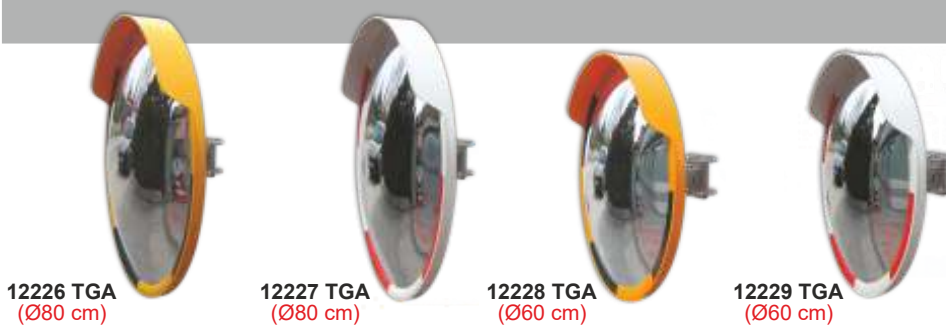

Product Technical Specificaons				
code	12226 TGA	12227 TGA	12228 TGA	12229 TGA
size (Ø)-Epaisseur acrylique	Ø800mm-2mm	Ø800mm-2mm	Ø600mm-2mm	Ø600mm-2mm
Weight (approx)	6.0 kg	6.0 kg	4.0 kg	4.0 kg
Material(mirror-cover)	Acrilic-PPC	Acrilic-PPC	Acrilic-PPC	Acrilic-PPC



Product Technical Specificaons				
code	12248 TGA	12246 TGA	12267 TGA	12265 TGA
size (Ø)-Epaisseur acrylique	600x800mm-2mm	600x800mm-2mm	400x600mm-2mm	400x600mm-2mm
Weight (approx)	5.65 kg	5.65 kg	3.6 kg	3.6 kg
Material(mirror-cover)	Acrilic-ABS	Acrilic-ABS	Acrilic-ABS	Acrilic-ABS

CORNER GUARDS



12296 UB R 12294 UB R 12295 UB R 12292 UB R



Product Technical Specifications

code	12296 UB R	12294 UB R	12295 UB R	12292 UB R
size(LxWxH)	70x120x800 mm	70x120x800 mm	80x9.0cm	90x140x900 mm
Weight (approx)	1.9 kg	1.9 kg	2.0 kg	1.85 kg
Material	PVC	PVC	PVC	PVC-PE

TACTILE FLOOR MARKINGS

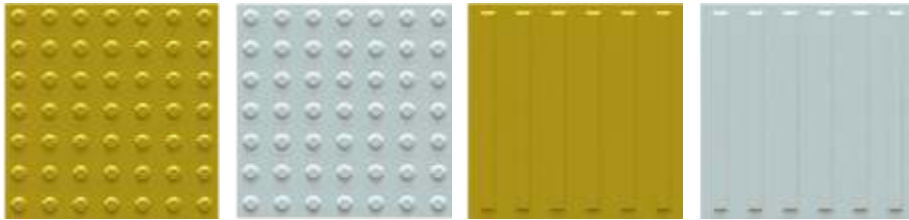

PL 8010 PL 8010-W PL 8012 PL 8012-W

Product Technical Specifications

code	PL 8010 PL 8010-W	PL 8012 PL 8012-W
size(LxWxH)	400x400 mm	400x400 mm
Weight (approx)	0.70 kg	0.85 kg
Material	TPU	TPU

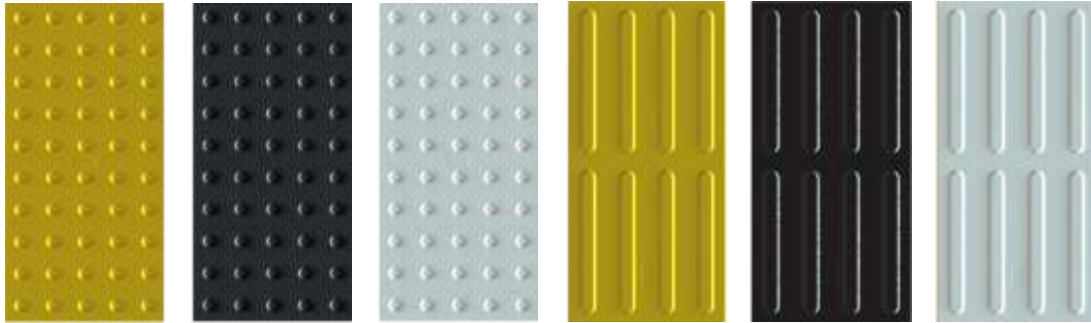

PL 8014 PL 8014-B PL 8014-W PL 8016 PL 8016-B PL 8016-W



code	PL 8014	PL 8014-B	PL 8014-W	PL 8016	PL 8016-B	PL 8016-W
size(LxWxH)	0.8x30x60 cm	0.8x30x60 cm	0.8x30x60 cm	0.8x30x60 cm	0.8x30x60 cm	0.8x30x60 cm
Weight (approx)	0.77 kg	0.77 kg	0.77 kg	0.90 kg	0.90 kg	0.90 kg
Material	TPU	TPU	TPU	TPU	TPU	TPU

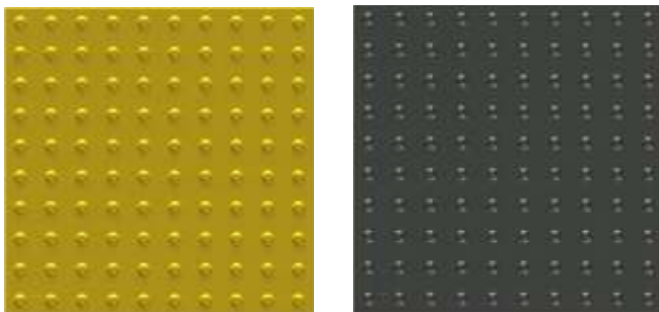

PL 8018 PL 8018-B

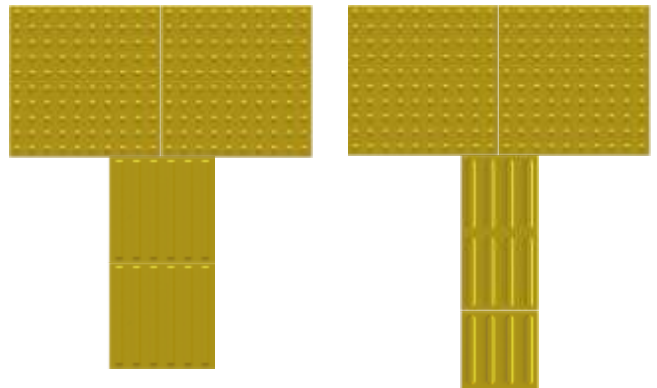

40x40 cm Tracking Surface

30x60 cm Tracking Surface

code	PL 8018	PL 8018-B
size(LxWxH)	0.8x58x58 cm	0.8x58x58 cm
Weight (approx)	1.40 kg	1.40 kg
Material	TPU	TPU

REFLECTIVE SELF-ADHESIVE TAPES

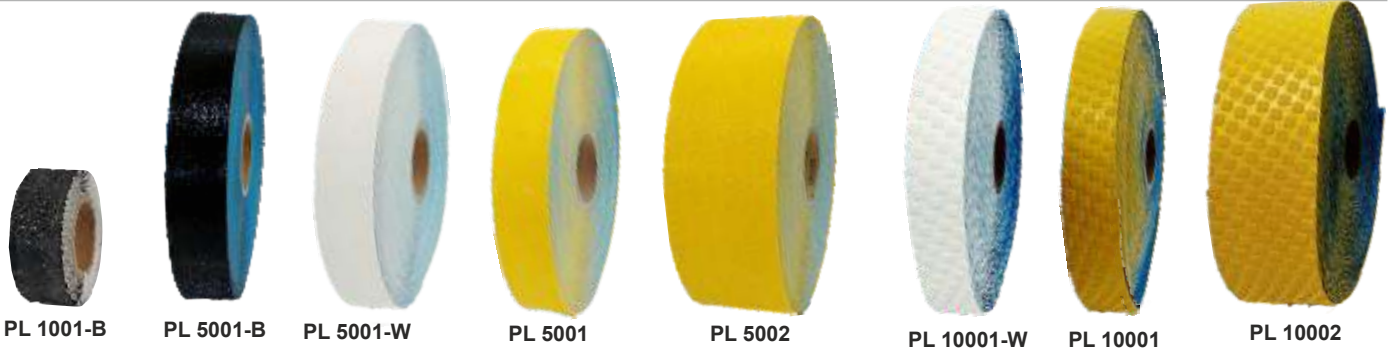

Product Technical Specificaons

code	PL 1001-B	PL 5001-B	PL 5001-W	PL 5001	PL 5002	PL 10001-W	PL 10001	PL 10002
size	5 cmx33 m/roll	5 cmx33 m/roll	5 cmx33 m/roll	5 cmx33 m/roll	10 cmx33 m/roll	5 cmx33 m/roll	5 cmx33 m/roll	10 cmx33 m/roll

REFLECTIVE SELF-ADHESIVE TAPES



Product Technical Specificaons

code	ETR 5111	ETR 5112	ETR 5115	ETR 5116	ETR 5121	ETR 5122
color	Red-White	Red-White	Kırmızı-yellow	Kırmızı-yellow	yellow-Black	yellow-Black
size	5cmx10m/roll	10cmx10m/roll	5cmx10m/roll	10cmx10m/roll	5cmx10m/roll	10cmx10m/roll
Type	Glass_ Beads	Glass_ Beads	Glass_ Beads	Glass_ Beads	Glass_ Beads	Glass_ Beads

REFLECTIVE SELF-ADHESIVE TAPES

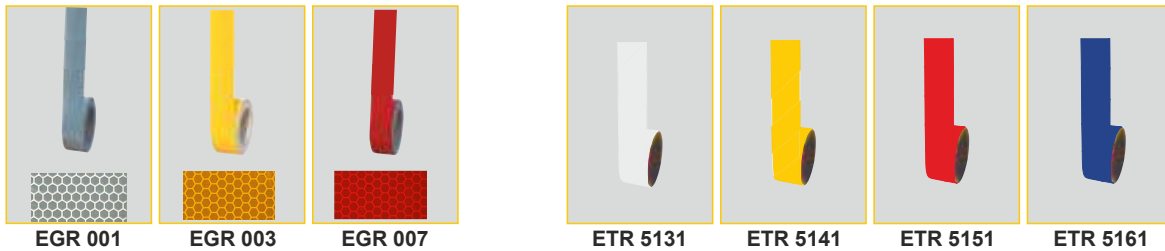

Product Technical Specificaons

code	EGR 001	EGR 003	EGR 007	ETR 5131	ETR 5141	ETR 5151	ETR 5161
color	Beyaz	yellow	Kırmızı	Beyaz	yellow	Kırmızı	Blue
size	5cmx30m/roll	5cmx30m/roll	5cmx30m/roll	5cmx10m/roll	5cmx10m/roll	5cmx10m/roll	5cmx10m/roll
back Reflection	400 cd/lux	300 cd/lux	70 cd/lux	-	-	-	-
Type	Microprismatic	Microprismatic	Microprismatic	Glass_ Beads	Glass_ Beads	Glass_ Beads	Glass_ Beads



Ultra Channelizer panels



12423 DB R A



12425 DB R A

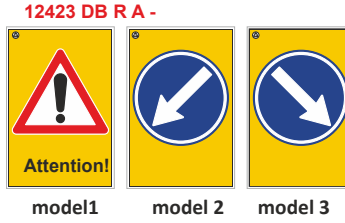

12423 DB R A -

model1

model 2

model 3

FLEXIBLE CHANNELIZER PANELS



12413 DB R

Reflective ASTM D 4956-11a Type I TS EN 13422+A1

- ▲ Easily portable practical body
- ▲ chain carrying channels in the side walls
- ▲ Weighted base with strong resistance to tipping grooved lamp / sheet insertion slot
- ▲ Lamp and ability plate fitted with more effective warning

Product Technical Specifications

code	12423 DB R A	12425 DB R A	12413 DB R
size (LxWxH)	495x395x905mm	495x395x905mm	340x100x800mm
Weight (approx)	7.0 kg	7.0 kg	4.5 kg
Material(body-pannel)	PPC-PVC	PPC-PVC	TPU-PVC

SAFETY ROAD BARRIERS



12520 FB R
RED



12526 FB R
(Solar Flasher)



Product Technical Specifications

code	12520 FB R	12526 FB R
size Bariyer (LxWxH)	400x1000x600mm	400x1000x600mm
Weight (approx)	20.0 kg	20.0 kg
Material(Body-Base)	PPC-PVC	PPC-PVC



12524 FB R



12522 FB R



Product Technical Specifications

code	12524 FB R	12522 FB R
size Bariyer (LxWxH)	400x1000x600mm	400x1000x600mm
Weight (approx)	20.0 kg	20.0 kg
Material(Body-Base)	PPC-PVC	PPC-PVC

SAFETY BARRICADES



12510 FB R



12512 FB R
(WxH)100x52 cm

Product Technical Specifications

code	12510 FB R	12512 FB R
size(LxWxH)	1500x1000mm	1500x1000mm
Weight (approx)	12.0 kg	12.3 kg
Material(Body-Base)	PPC-PVC	PPC-PVC

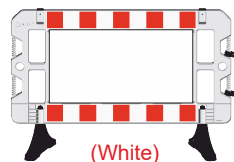

(White)

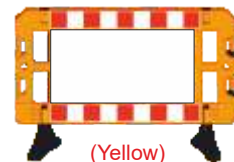

(Yellow)

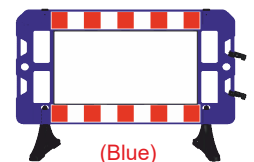

(Blue)

SPEED RAMPS (reflective tapes)

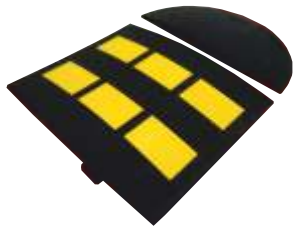

12116 YK - 12109 YK K



12108 YK - 12109 YK K



12110 YK - 12111 YK K

Product Technical Specificaons						
code	12116 YK	12109 YK K	12108 YK	12109 YK K	12110 YK	12111 YK K
size(LxWxH)	600x500x45mm	600x300x45mm	600x500x45mm	600x300x45mm	400x500x40mm	400x200x40mm
Weight (approx)	9.3 kg	3.4 kg	9.3 kg	3.4 kg	6.5 kg	1.65 kg
Material	PVC Compound	PVC Compound	PVC Compound	PVC Compound	PVC Compound	PVC Compound

Reflective Tape Specs.	
Min. Coefficient of Retroreflection	
Color	Yellow
Entrance Angle	88,76°
Observation Angle	1,05°
Measurement (mcd/m ² /lx)	500

SPEED RAMPS (reflective lenses)



12106 YK - 12107 YK K



12104 YK - 12105 YK K

Product Technical Specificaons				
code	12106 YK	12107 YK K	12104 YK	12105 YK K
size(LxWxH)	400x500x40mm	400x200x40mm	500x300x45mm	500x250x45mm
Weight (approx)	6.5 kg	1.65 kg	6.25 kg	3.0 kg
Material	PVC Compound	PVC Compound	PVC Compound	PVC Compound



yellow / Black color

SPEED RAMPS/ PPC /Cat_Eyes

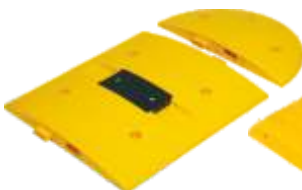

12112 YK - 12113 YK K



12100 YK - 12101 YK K



12102 YK - 12103 YK K



11938 SL - 11940 SL K

Solar Flasher

Product Technical Specificaons								
code	12112 YK	12113 YK K	12100 YK	12101 YK K	12102 YK	12103 YK K	11938 SL	11940 SL K
size(LxWxH)	500x500x45	500x250x45	250x350x50	250x100x50	300x333x40	300x100x40	500x500x45	500x250x45
Weight (approx)	3.10 kg	1.1 kg	1.5 kg	0.36 kg	1.35 kg	0.25 kg	3.10 kg	1.1 kg
Material	PPC	PPC	PPC	PPC	PPC	PPC	PPC	PPC

Electronic Specs.		
Solar Panel	Type	Monocrystalline silicon cell
	Dimensions	60x54 mm
	Voltage	3 V
	Current	120 mA
	Material	Ni-MH
Battery	Voltage	1.2 V
	Current	2000 mA/h
	Color	Yellow-red
	Dimensions	∅ 5 mm
LED	Flash Rate	120 f/min
	Visibility Dist.	300 m (night)
	Operation Time	whole night/daily sunlight
Operation Temp.		-20°C/+60°C

Cable protector



12299 UB

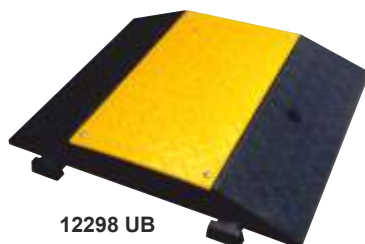

12298 UB

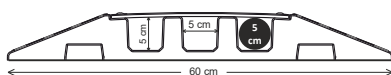

Product Technical Specificaons		
code	12299 UB	12298 UB
size(LxWxH)	600x500x75mm	600x500x75mm
Weight (approx)	3.0 kg	8.7 kg
Material	PPC	PPC

ROAD LANE SEPERATORS

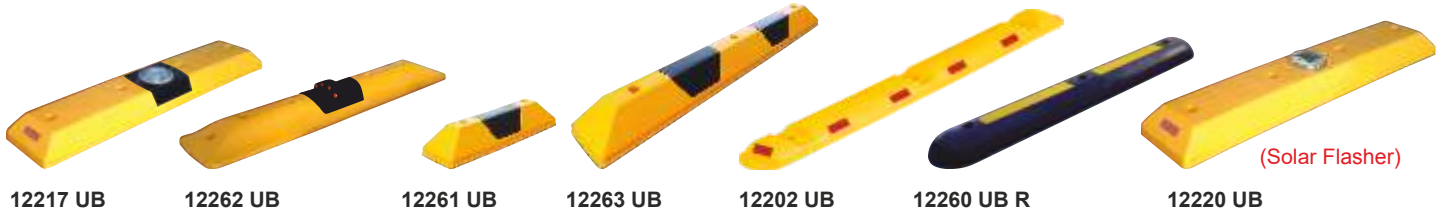

Product Technical Specificaons

code	12217 UB	12262 UB	12261 UB	12263 UB	12202 UB	12260 UB R	12220 UB
size(LxWxH)	1000x200x80mm	1000x220x80mm	550x150x100mm	1100x150x100mm	1200x150x50mm	1000x150x60mm	1000x200x80mm
Weight (approx)	4.1 kg	3.5 kg	1.9 kg	4.25 kg	2.3 kg	6.0 kg	3.7 kg
Material	PPC	PPC	PPC	PPC	PPC	PVC	PPC

SOLAR ROAD MARKERS



Product Technical Specificaons

code	11924 SL K	11926 SL S	11920 SL K	11922 SL S	11921 SL K	11923 SL S
size(LxWxH)	125x145x28mm	125x145x28mm	125x145x28mm	125x145x28mm	120x135x28mm	120x135x28mm
Weight (approx)	0.48 kg	0.48 kg	0.45 kg	0.45 kg	0.57 kg	0.57 kg
Material	AL	AL	AL	AL	AL	AL
material	Ø30xL50 Stud	Ø30xL50 Stud	Ø14xL70xØ8 mm	Ø14xL70xØ8 mm	Ø14xL70xØ8 mm	Ø14xL70xØ8 mm

Electronic Specs.

	Type	Monocrystalline silicon cell
Solar Panel	Dimensions	60x54 mm
	Voltage	3 V
	Current	120 mA
	Material	Ni-MH
Battery	Voltage	1.2 V
	Current	2000 mA/h
	Color	Yellow-red
	Dimensions	Ø 5 mm
	Flash Rate	120 f/min
LED	Visibility Dist.	300 m (night)
	Operation Time	whole night/daily sunlight
	Operation Temp.	-20°C/+60°C

ROAD MARKERS



Product Technical Specificaons

code	12011 YB	12007 YB	12009 YB	12005-2 YB	12005-3 YB
size(LxWxH)	2.1x10x10cm	2.8x12x12cm	2.1x10x10cm	2.1x10x10cm	2.1x10x10cm
Weight (approx)	0.40 kg	0.30 kg	0.15 kg	0.15 kg	0.15 kg
Material	AL	AL	ABS	ABS	ABS
Screw	Ø2.0x(H)5.0 cm epoksi yapıştırıcı ile				
	Ø1.4x(H)7.0xØ0.8 cm vida&dübel ile x 2 Adet				

ROAD MARKERS

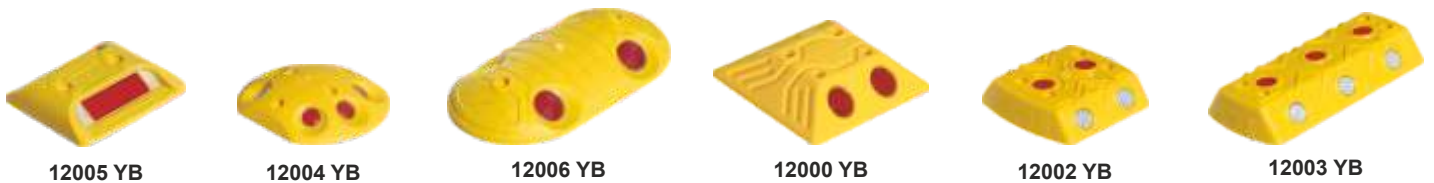

Product Technical Specificaons

code	12005 YB	12004 YB	12006 YB	12000 YB	12002 YB	12003 YB
size(LxWxH)	2.0x10.5x10.5cm	2.5x14x12cm	2.8x22x12cm	3.2x15x12.5cm	2.8x12x12cm	3.2x22x10cm
Weight (approx)	0.12 kg	0.12 kg	0.22 kg	0.20 kg	0.18 kg	0.24 kg
Material	ABS	PPC	PPC	PPC	PPC	PPC
screw	Ø14xL70xØ8 mm	Ø6xL105mm nail	Ø14xL70xØ8 mm		Ø6xL105mm nail	

Solar Flasher LED



11825 FL S

11827 FL K

11811 FL S

11813 FL K

Product Technical Specifications

code	11825 FL S	11827 FL K	11811 FL S	11813 FL K
size (LxWxH)	90x215x290mm	90x215x290mm	90x235x290mm	90x235x290mm
Weight (approx)	0.750 kg	0.750 kg	0.840 kg	0.840 kg
Material(body-base)	PC - ABS	PC - ABS	PC - ABS	PC - ABS

Electronic Specs.

Solar Panel	Type	Monocrystalline silicon cell
	Dimensions	120x45 mm
	Voltage	4.3 V
	Current	80 mA
Battery/LED	Material	Ni-MH
	Voltage	2x1.2 V
	Current	2300 mA/h
	Color	Yellow-red
Dimensions	Ø 5 mm	
Flash Rate	105 f/min	
Visibility Dist.	500 m (night)	
Operation Time	whole night/daily sunlight	
Operation Temp.	-20°C/+60°C	

Solar Flasher LED



11814 FL S

11816 FL K

11817 FL K

11819 FL S

11821 FL M

Product Technical Specifications

code	11814 FL S	11816 FL K	11817 FL K	11819 FL S	11821 FL M
size	(LxWxH)80x220x270	(LxWxH)80x220x270	(ØxH)128x145mm	(ØxH)128x145mm	(ØxH)128x145mm
Weight (approx)	0.500 kg	0.500 kg	0.350 kg	0.350 kg	0.350 kg
Material(body-base)	PC - ABS	PC - ABS	PC - PA	PC - PA	PC - PA

Electronic Specs.

Solar Panel	Type	Monocrystalline silicon cell
	Dimensions	120x45 mm
	Voltage	4.3 V
	Current	80 mA
Battery/LED	Material	Ni-MH
	Voltage	2x1.2 V
	Current	2300 mA/h
	Color	Yellow-red-blue
Dimensions	Ø 5 mm	
Flash Rate	115 f/min	
Visibility Dist.	500 m (night)	
Operation Time	whole night/daily sunlight	
Operation Temp.	-20°C/+60°C	

LED Flasher

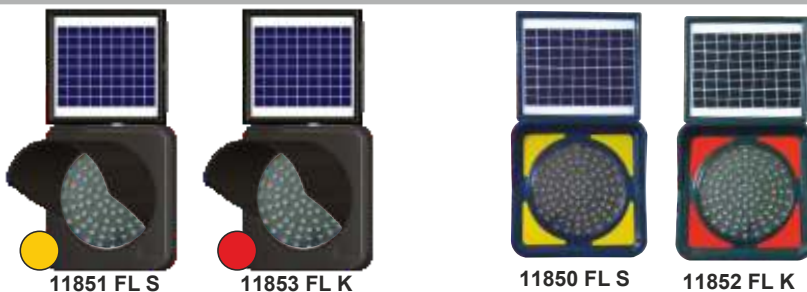

11851 FL S

11853 FL K

11850 FL S

11852 FL K

Product Technical Specifications

code	11851 FL S	11853 FL K	11850 FL S	11852 FL K
size-cover (LxW)	40x40 cm	40x40 cm	400x400 mm	400x400 mm
size-lens (Ø)/mark(LxW)	Ø30 cm	Ø30 cm	300 mm	300 mm
Weight (approx)	8.0 kg	8.0 kg	7.6 kg	7.6 kg
Material(body-pannel)	PC	PC	PC - Reflec. v	PC - Reflectiv

Electronic Specs.

Solar Panel	Type	Glass laminated
	Dimensions	345x293 mm
	Voltage	10 V
	Current	0.65 A
Battery/LED	Material	SLA
	Voltage	12 V
	Current	7.0 mA/h
	Color	Yellow-Red
Dimensions	Ø 10 mm x 102 pcs	
Flash Rate	65 f/min	
Visibility Dist.	500 m (night)	
Operation Time	whole night/daily sunlight	
Operation Temp.	-20°C/+60°C	

LED Sign

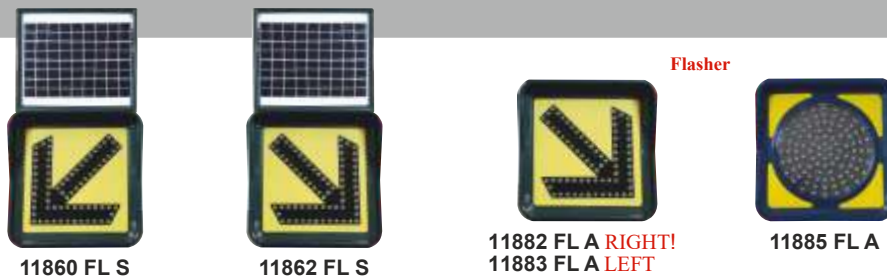

11860 FL S

11862 FL S

11882 FL A RIGHT!
11883 FL A LEFT!

11885 FL A

Product Technical Specifications

code	11860 FL S	11862 FL S	11882 FL A	11883 FL A	11885 FL A
size-cover (LxW)	40x40 cm	40x40 cm	40x40 cm	40x40 cm	40x40 cm
Weight (approx)	7.0 kg	7.0 kg	2.8 kg	2.8 kg	3.1 kg
Material(body-pannel)	PC - Reflektif	PC - Reflektif	PC - Reflektif	PC - Reflektif	PC - Reflektif

Electronic Specs.

Voltage	12 V AC	
	220 V AC	
LED	Color	Yellow
	Dimensions	Ø 10 mm
	Flash Rate	65 f/min
	Visibility Dist.	500 m (night)
	Operation Time	whole night/daily sunlight
Operation Temp.	-20°C / +60°C	

Solar LED Road Maintenance Boards



Product Technical Specifications				
code	11836 FL	11843 FL	11844 FL	11845 FL
size(LxW)	600x600mm	600x600mm	600x600mm	600x600mm
Weight (approx)	9.75kg	9.75kg	9.75kg	9.75kg
Material(Body-floor)	PC-Reflective ASTM D 4956-11a Tip I			



Solar LED Road Maintenance Boards



Product Technical Specifications					
code	11837 FL	11800-32 FL	11800-38 FL	11842 FL	11800-36 FL
mesure(LxW)	600x600mm	600x600mm	600x600mm	600x600mm	600x600mm
Weight (approx)	9.75kg	9.75kg	9.75kg	9.75kg	9.75kg
Material(Body-floor)	PC-Reflec. ve ASTM D 4956-11a Tip I				

Electronic Specs.		
Solar Panel	Type	Glass laminated
	Dimensions	345x293 mm
	Voltage	10 V
	Current	0.65 A
	Material	SLA
Battery/ LED	Voltage	12 V
	Current	7.0 mA/h
	Color	Red-white
	Dimensions	ø5 mm
	Flash Rate	54 f/min
Visibility Dist.	500 m (night)	
Operation Time	whole night/daily sunlight	
Operation Temp.	-20°C/+60°C	

Solar LED Road Maintenance Boards

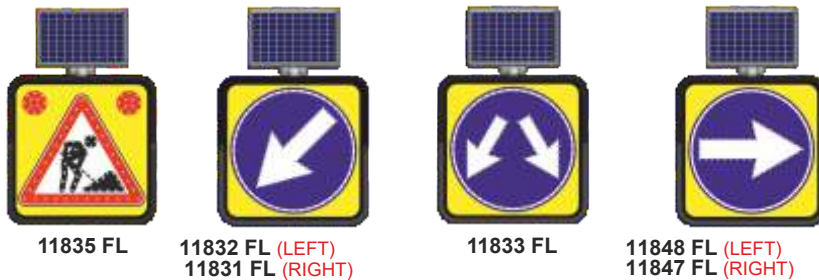

Product Technical Specifications						
code	11835 FL	11832 FL	11831 FL	11833 FL	11848 FL	11847 FL
mesure(LxW)	600x600mm	600x600mm	600x600mm	600x600mm	600x600mm	600x600mm
Weight (approx)	9.75kg	9.75kg	9.75kg	9.75kg	9.75kg	9.75kg
Material(Body-floor)	PC-Reflective ASTM D 4956-11a Tip I					

Electronic Specs.		
Solar Panel	Type	Glass laminated
	Dimensions	345x293 mm
	Voltage	10 V
	Current	0.65 A
	Material	SLA
Battery/ LED	Voltage	12 V
	Current	7.0 mA/h
	Color	Red-white
	Dimensions	ø5 mm
	Flash Rate	54 f/min
Visibility Dist.	500 m (night)	
Operation Time	whole night/daily sunlight	
Operation Temp.	-20°C/+60°C	

Solar LED Road Maintenance Boards

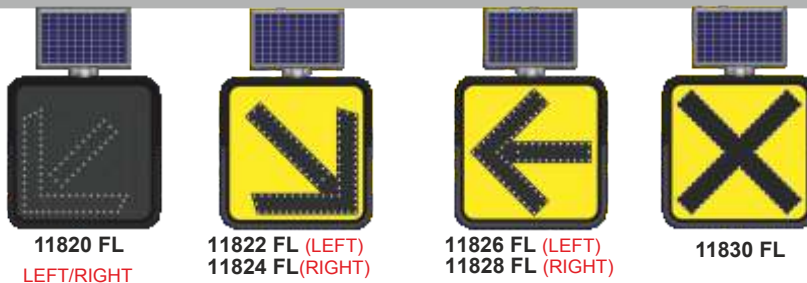

Product Technical Specifications						
code	11820 FL	11822 FL	11824 FL	11826 FL	11828 FL	11830 FL
mesure(LxW)	600x600mm	600x600mm	600x600mm	600x600mm	600x600mm	600x600mm
Weight (approx)	9.75kg	9.75kg	9.75kg	9.75kg	9.75kg	9.75kg
Material(Body-floor)	PC-Reflekt ASTM D 4956-11a Tip I					

Solar Flasher LED Traffic Signs

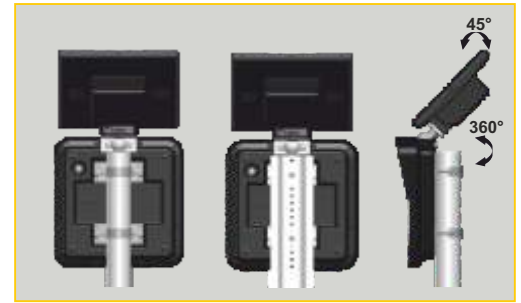
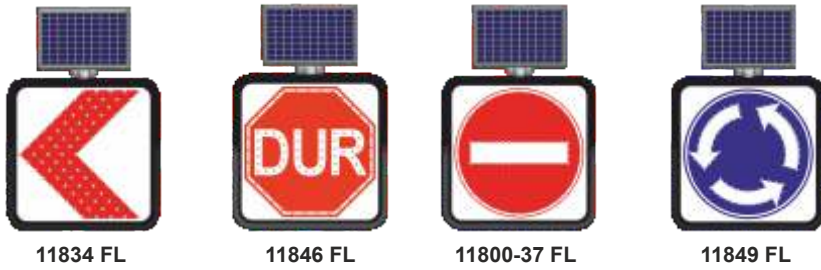

Product Technical Specifications

code	11834 FL	11846 FL	11800-37 FL	11849 FL
size(LxW)	600x600mm	600x600mm	600x600mm	600x600mm
Weight (approx)	9.75kg	9.75kg	9.75kg	9.75kg
Material(Body-floor)	PC-Reflective ASTM D 4956-11a Tip I			

Solar Flasher LED Traffic Signs



Product Technical Specifications

code	11838 FL	11839 FL	11840 FL	11841 FL
size(LxW)	600x600mm	600x600mm	600x600mm	600x600mm
Weight (approx)	9.75kg	9.75kg	9.75kg	9.75kg
Material(Body-floor)	PC-Reflec. ve ASTM D 4956-11a Tip I			

Elektronik Devre Teknik Özellikler

Solar Panel	Tip	Glass Laminated
	size	345x293 mm
	voltage	18 V
	Wa.	10 W
Battery/LED	Material	SLA
	voltage	12 V
	Current	7.0 mA/h
	color	Beyaz
	size	Ø 5 mm
	Flash number	54 f/min
	Warning Distanc	500 m (night)
	Operation time	charging in daylight tüm night
	Operating tempe	-20°C/+60°C

AC/ Road Maintenance Led Sign



Product Technical Specifications

Part No.	11884 FL A	11886 FL A	11888 FL A	11889 FL A	11890 FL A
Dim.(LxW)	600x600 mm	600x600 mm	600x600 mm	600x600 mm	600x600 mm
Weight (approx.)	5.5 kg	5.5 kg	5.5 kg	5.5 kg	5.5 kg
Material (cover-surface)	PC-Reflective sheeting	PC-Reflective sheeting	PC-Reflective sheeting	PC-Reflective sheeting	PC-Reflective sheeting

Product Technical Specifications

code	11884 FL A	11886 FL A	11888 FL A	11889 FL A	11890 FL A
size(LxW)	600x600mm	600x600mm	600x600mm	600x600mm	600x600mm
Weight (approx)	5.5kg	5.5kg	5.5kg	5.5kg	5.5kg
Material(Body-floor)	PC-Reflective ASTM D 4956-11a Tip I				

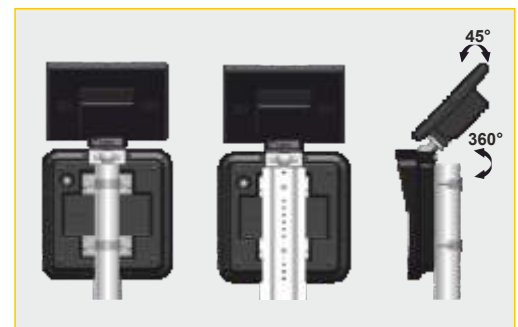
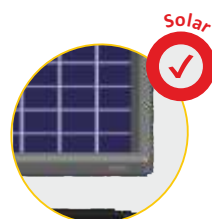

Solar LED Road Maintenance Boards



Electronic Specs.		
Solar Panel	Type	Glass laminated
	Dimensions	345x293 mm
	Voltage	10 V
	Current	0.65 A
Battery/LED	Material	SLA
	Voltage	12 V
	Current	7.0 mA/h
	Color	White-Red
	Dimensions	Ø5 mm
	Flash Rate	54 f/min
	Visibility Dist.	500 m (night)
	Operation Time	whole night/daily sunlight
	Operation Temp.	-20°C/+60°C

Product Technical Specifications			
code	11764 S-LD	11730 S-LD	11762 S-LD
size(LxW)	1000x1000mm	1000x1000mm	1000x1000mm
Weight (approx)	19.0kg	19.0kg	19.0kg
Material(Body-floor)	AL-Reflective ASTM D 4956-11a Tip I		

Solar LED Road Maintenance Boards



Product Technical Specifications					
code	11732 S-LD	11734 S-LD	11736 S-LD	11738 S-LD	11766 S-LD
size(LxW)	1000x1000mm	1000x1000mm	1000x1000mm	1000x1000mm	1000x1000mm
Weight (approx)	19.0kg	19.0kg	19.0kg	19.0kg	19.0kg
Material(Body-floor)	AL-Reflective ASTM D 4956-11a Tip I				

Solar LED Road Maintenance Boards

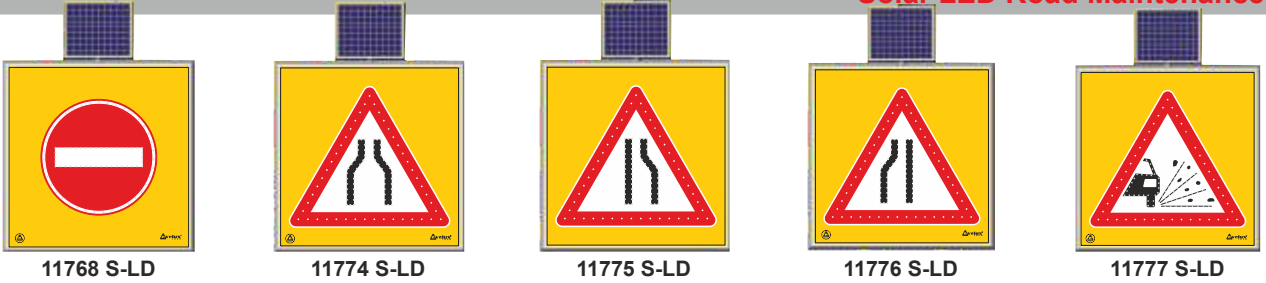

Product Technical Specifications					
code	11768 S-LD	11774 S-LD	11775 S-LD	11776 S-LD	11777 S-LD
size(LxW)	1000x1000mm	1000x1000mm	1000x1000mm	1000x1000mm	1000x1000mm
Weight (approx)	19.0kg	19.0kg	19.0kg	19.0kg	19.0kg
Material(Body-floor)	AL-Reflective ASTM D 4956-11a Tip I				

Solar LED Road Maintenance Boards



Product Technical Specifications					
code	11740 S-LD	11742 S-LD	11744 S-LD	11748 S-LD	11746 S-LD
size(LxW)	1000x1000mm	1000x1000mm	1000x1000mm	1000x1000mm	1000x1000mm
Weight (approx)	19.0kg	19.0kg	19.0kg	19.0kg	19.0kg
Material(Body-floor)	AL-Reflec. ve ASTM D 4956-11a Tip I				

Solar LED Road Maintenance Boards

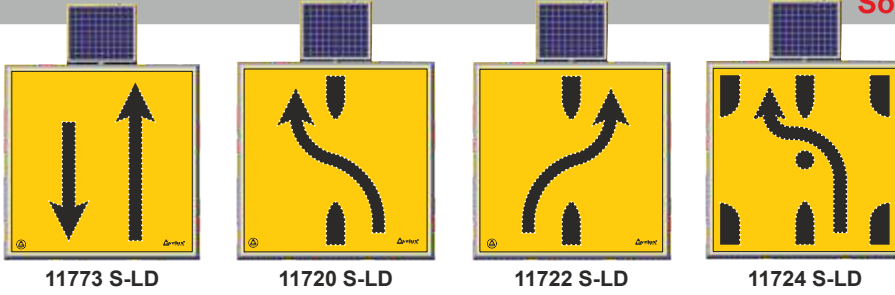

11773 S-LD

11720 S-LD

11722 S-LD

11724 S-LD

Product Technical Specifications

code	11773 S-LD	11720 S-LD	11722 S-LD	11724 S-LD
size(LxW)	1000x1000mm	1000x1000mm	1000x1000mm	1000x1000mm
Weight (approx)	19.0kg	19.0kg	19.0kg	19.0kg
Material(Body-floor)	AL-Reflective ASTM D 4956-11a Tip I			

Electronic Specs.

	Type	Glass laminated
Solar Panel	Dimensions	345x293 mm
	Voltage	10 V
	Current	0.65 A
	Material	SLA
Battery/LED	Voltage	12 V
	Current	7.0 mA/h
	Color	Yellow
	Dimensions	ø5 mm
	Flash Rate	54 f/min
	Visibility Dist.	500 m (night)
	Operation Time	whole night/daily sunlight
	Operation Temp.	-20°C/+60°C

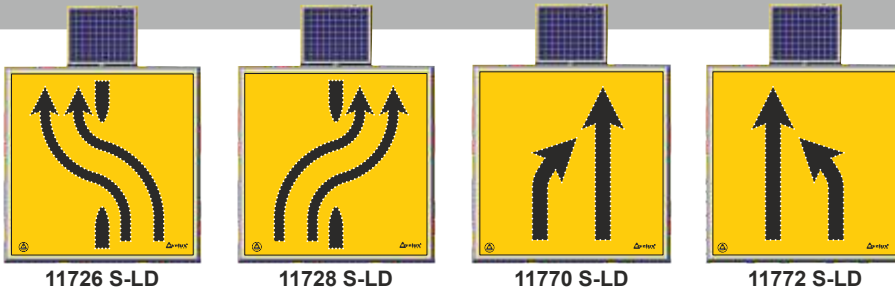

11726 S-LD

11728 S-LD

11770 S-LD

11772 S-LD

Product Technical Specifications

code	11726 S-LD	11728 S-LD	11770 S-LD	11772 S-LD
size(LxW)	1000x1000mm	1000x1000mm	1000x1000mm	1000x1000mm
Weight (approx)	19.0kg	19.0kg	19.0kg	19.0kg
Material(Body-floor)	AL-Reflective ASTM D 4956-11a Tip I			

Solar LED Road Maintenance Boards

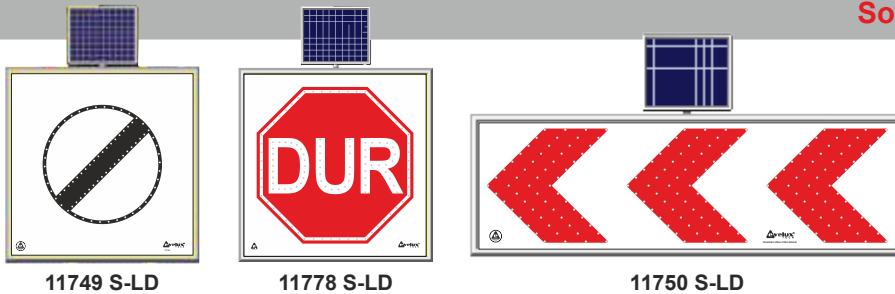

11749 S-LD

11778 S-LD

11750 S-LD

Product Technical Specifications

code	11749 S-LD	11778 S-LD	11750 S-LD
size(LxW)	1000x1000mm	1000x1000mm	500x1500mm
Weight (approx)	19.0kg	19.0kg	19.0kg
Material(Body-floor)	AL-Reflective ASTM D 4956-11a Tip I		

Electronic Specs.

	Type	Glass laminated
Solar Panel	Dimensions	345x293 mm
	Voltage	10 V
	Current	0.65 A
	Material	SLA
Battery/LED	Voltage	12 V
	Current	7.0 mA/h
	Color	Red-White
	Dimensions	ø5 mm
	Flash Rate	54 f/min
	Visibility Dist.	500 m (night)
	Operation Time	whole night/daily sunlight
	Operation Temp.	-20°C/+60°C

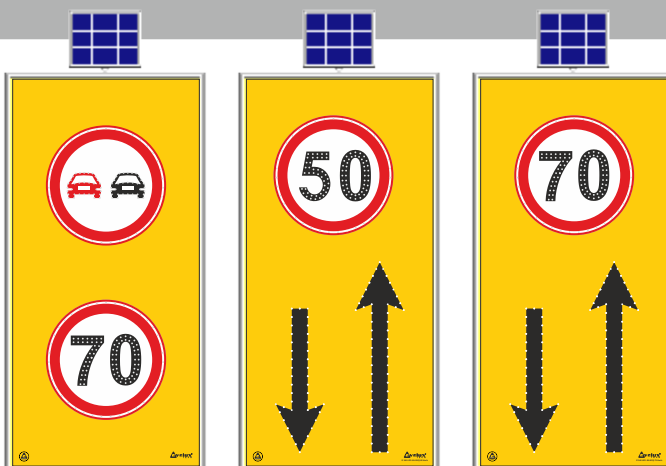

11716 S-LD

11710 S-LD

11712 S-LD

Product Technical Specifications

code	11716 S-LD	11710 S-LD	11712 S-LD
size(LxW)	1000x1750mm	1000x1750mm	1000x1750mm
Weight (approx)	28.0kg	28.0kg	28.0kg
Material(Panel)	Reflective ASTM D 4956-11a Tip I		

TRAFFIC SIGN BOARDS

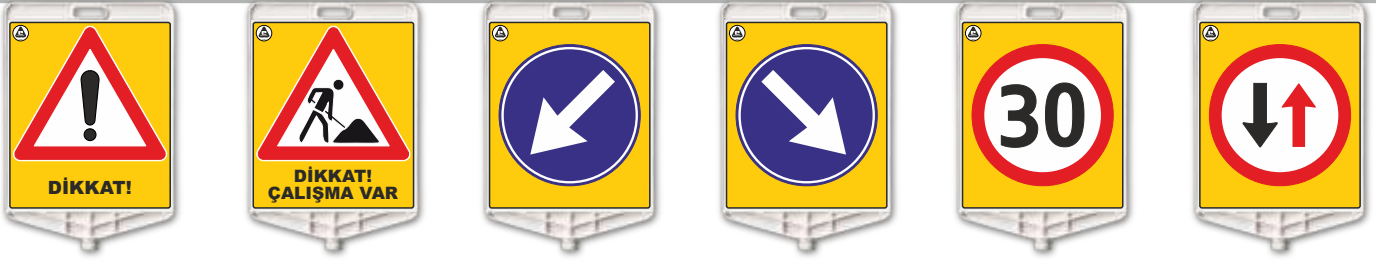

316 A R

317 A R

315 A R

314 A R

308 A R

311 A R

Product Technical Specificaons

code	316 A R	317 A R	315 A R	314 A R	308 A R	311 A R
size(WxH)	350x410 mm	350x410 mm	350x410 mm	350x410 mm	350x410 mm	350x410 mm
Material	PPC	PPC	PPC	PPC	PPC	PPC
Retroreflecivity	30 cd/lux	30 cd/lux	30 cd/lux	30 cd/lux	30 cd/lux	30 cd/lux

TRAFFIC SIGN BOARDS

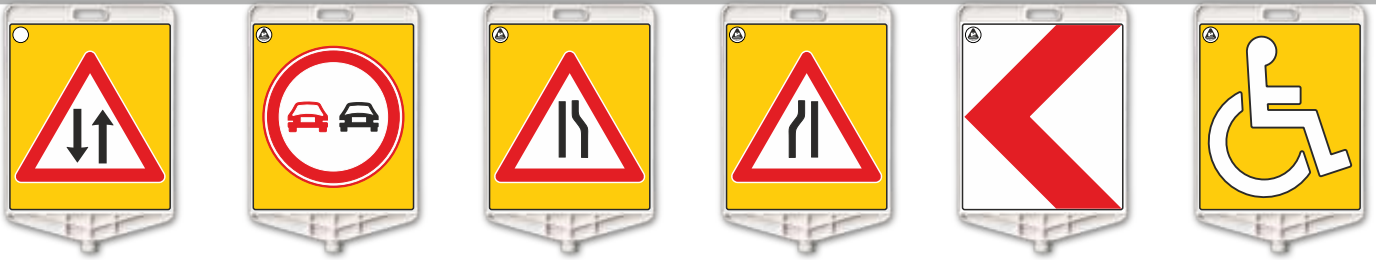

313 A R

312 A R

309 A R

310 A R

325 A R

326 A R

Product Technical Specificaons

code	313 A R	312 A R	309 A R	310 A R	325 A R	326 A R
size(WxH)	350x410 mm	350x410 mm	350x410 mm	350x410 mm	350x410 mm	350x410 mm
Material	PPC	PPC	PPC	PPC	PPC	PPC
Retroreflecivity	30 cd/lux	30 cd/lux	30 cd/lux	30 cd/lux	30 cd/lux	30 cd/lux

TRAFFIC SIGN BOARDS



130 A R

131 A R

133 A R

134 A R

Product Technical Specificaons

code	130 A R	131 A R	133 A R	134 A R
size(H)	390 mm	390 mm	390 mm	390 mm
Material	PPC	PPC	PPC	PPC
Retroreflecivity	30 cd/lux	30 cd/lux	30 cd/lux	30 cd/lux

TRAFFIC SIGN BOARDS



132 A R

135 A R

141 A R

169 A R

Product Technical Specificaons

code	132 A R	135 A R	141 A R	169 A R
size(H)	390 mm	390 mm	390 mm	390 mm
Material	PPC	PPC	PPC	PPC
Retroreflecivity	30 cd/lux	30 cd/lux	30 cd/lux	30 cd/lux

TRAFFIC SIGN BOARDS



222 A R



229 A R



230 A R



234 A R



221 A R



239 A R



233 A R



295 A F

Product Technical Specifications

code	222 A R	229 A R	230 A R	234 A R	221 A R	239 A R	233 A R	295 A F
size	Ø380 mm	Ø380 mm	Ø380 mm	Ø380 mm	Ø380 mm	Ø380 mm	Ø380 mm	Ø380 mm
Material	PPC	PPC	PPC	PPC	PPC	PPC	PPC	PPC
Retroreflevcity	30 cd/lux	30 cd/lux	30 cd/lux	30 cd/lux	30 cd/lux	30 cd/lux	30 cd/lux	30 cd/lux

BLANK SIGN BOARDS



111 A



110 A



196 A



120 A



124 A F



113 A



114 A

Product Technical Specifications

code	111 A	110 A	196 A	120 A	124 A F	113 A	114 A
size	(WxH)350x410mm	(H)390mm	(Ø)380mm	(Ø)280mm	(Ø)280mm	(WxH)300x300mm	(WxH)315x340mm
Material	PPC	PPC	PPC	PPC	PPC-Folyo	PPC	PPC

CONE/DELINEATOR/POST ACCESSORIES



174 A



194 A



126 A



175 A



190 A

(5 kg)



128 A



129 A



152 A R Koni ve Dikme Barikat Profili

Product Technical Specifications

code	174 A	194 A	126 A	175 A	190 A	128 A	129 A	127 A	123 A	152 A R
size	Ø40 mm	Ø 80 mm	(WxH)70x105mm	(WxH)70x28mm	(WxH)385x50mm	25 m	25 m	3 m	3 m	(WxH)1500x50mm
Material	PPC	PPC	ABS	PP	PVC	PP	PP	PP	PP	PVC



127 A

123 A

BARRICADE ACCESSORIES



164 A



149 A



155 A



192 A



159 A



163 A



160 A



176 A



161 A



173 A



172 A

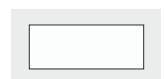

142 A



150 A

Product Technical Specifications

Part No.	164 A	149 A	142 A	150 A	155 A	192 A	159 A	163 A	160 A	176 A	161 A	173 A	172 A
size(ØxLxØ)	1250x750mm	1500x750mm	900x315mm	1500x315mm	Ø110 mm	130x35 mm	18x90x10 mm	14x70x8 mm	14x70x8 mm	10x105 mm	6x105 mm	14x70x8 mm	18x90x10mm
Material	PVC	PVC	PVC	PVC	PA	PA	-	-	-	-	-	-	-

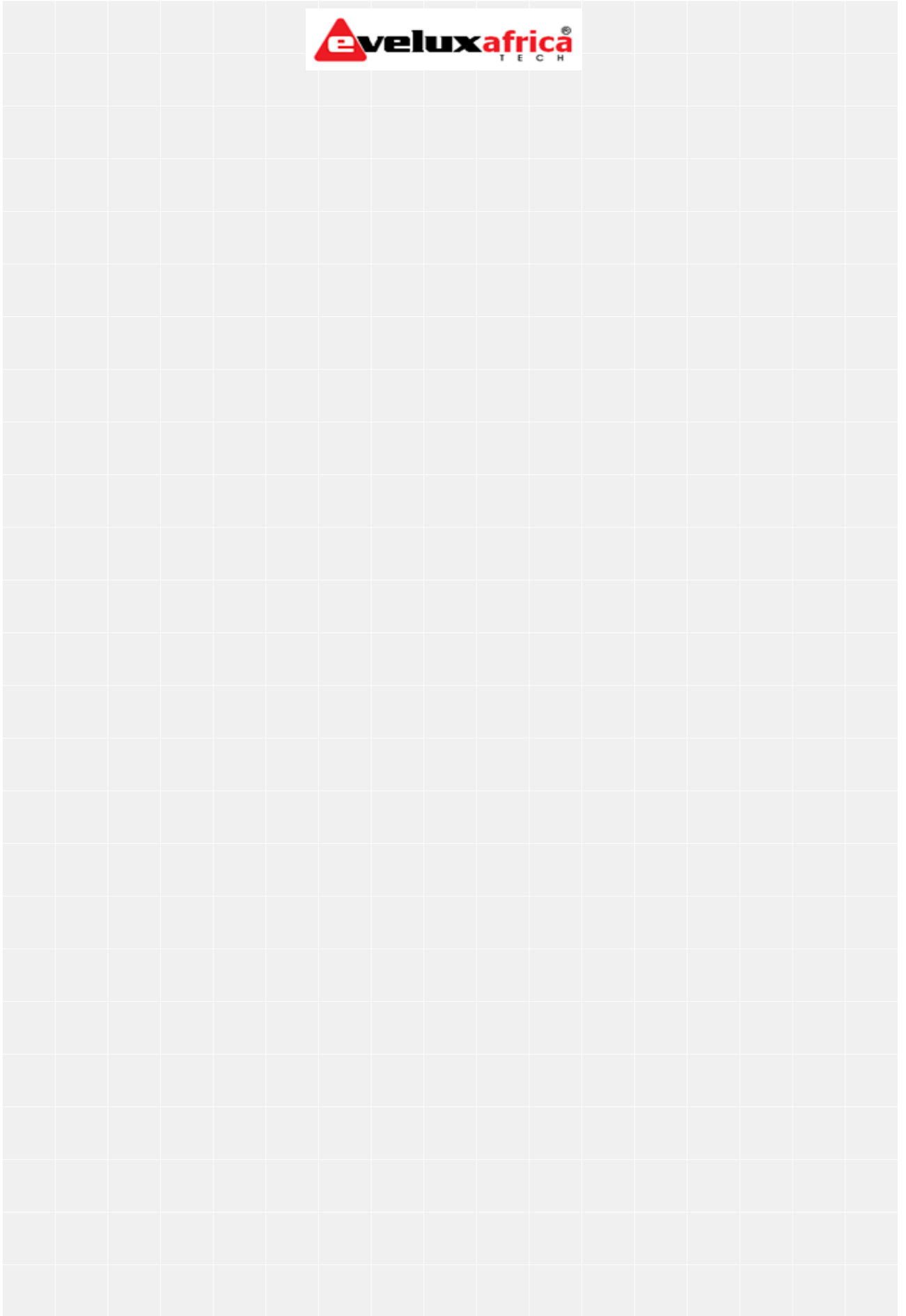





SAFETY ARSENAL

1 Rue Nouiri Sidi Fradj 2036 La Soukra Ariana
Tunisia Tel. +216 70 85 80 84

Gsm. +216 22 222 000 - +216 23 700 100

Mail : contact@safetyarsenal.com

